

MARCA A
MARK A

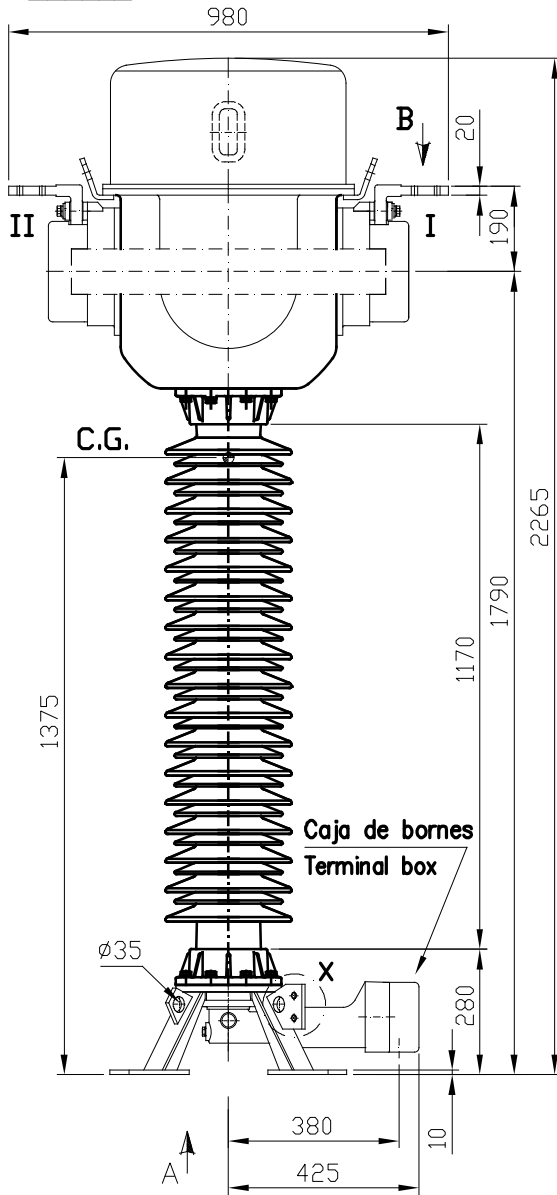

MARCA B
MARK B

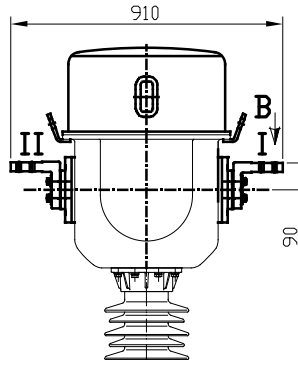

VISTA POR B
VIEW FOR B

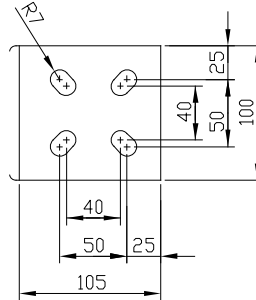

Indicador de nivel
Level indicator

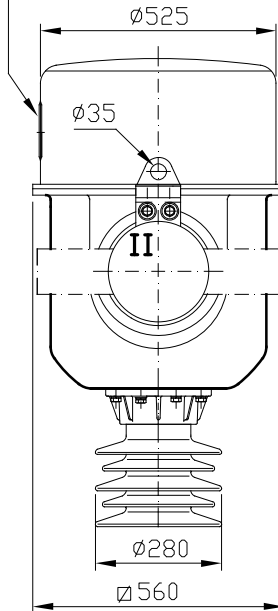

DETALLE X
DETAIL X

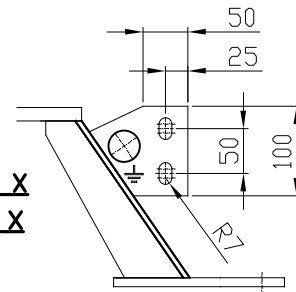

DIMENSIONES DE ANCLAJE
MOUNTING DIAGRAM

Toma muestras de aceite
Oil sampling valve

Toma tang. 8
Tang. 8 tap

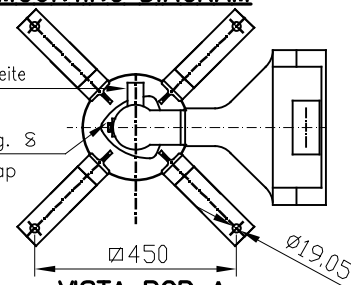

VISTA POR A
VIEW BY A

MARCA C
MARK C

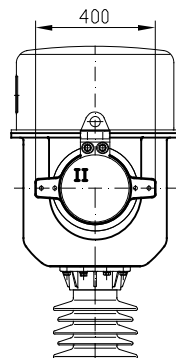

PESO WEIGHT	ACEITE-OIL	50 Kgs.	110 Lbs.
	TOTAL	275 Kgs.	605 Lbs.

I	II
---	----



Dimensiones aproximadas en m.m.
Approximate dimensions in m.m.

F TRANSFO DE INTENSIDAD
CURRENT TRANSFORMER

CA-123/F
CABEZA FUNDICION

Fecha
15.02.13

Comprobado

Dibujo número
4286442